

# AIRY STRUCTURE

SEED BEAD BRACELET

## PRECIOSA Twin™ more possibilities

ART. No., Size:

**PRECIOSA Twin™ seed beads**

321 96 001

321 97 001, matt

2.5 x 5 mm

**PRECIOSA Twin™ pressed beads**

117 01 323

2.5 x 5 mm



PRECIOSA

### BEAD SHOP ZÁSADA

468 25 Zásada  
+420 483 332 643  
beadshop@preciosa.com  
50°41'49 N, 15°15'55 E

### GLASS SHOP DESNÁ

Krkonošská, 468 61 Desná  
+420 483 343 525  
glassshop@preciosa.com  
50°45'41 N, 15°19'7 E

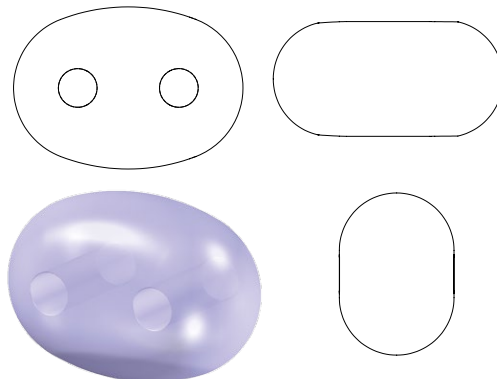

preciosa-ornela.com  
facebook.com/PreciosaOrnela

December 2012 © PRECIOSA ORNELA, a.s.



PRECIOSA ORNELA offers a further tutorial for the creation of an original and airy bracelet. The considered design is aimed at creating an interesting, strong and structurally pure, modern shape. You can create a bracelet according to our tutorial or use the detailed drawings to produce your own designs. PRECIOSA Twin™ will enable you to easily create interesting spatial shapes and original structures. The multilateral use of PRECIOSA Twin™ in combination with the exceedingly wide pallet of colors and finishes will provide you with endless inspiration. Allow yourself be drawn into the creative world of seed beads from the PRECIOSA Traditional Czech Beads brand.

### Materials and Tools:

-  PRECIOSA Twin™ (T)  
321 96 001; 2.5 x 5 mm; 1004x
-  PRECIOSA rocaille (R)  
331 19 001; 10/0; 78x



a thin stringing needle, a 0.20 mm thin line, scissors

Difficulty: 

### Procedure:





Gradually string the individual T and R seed beads according to the detailed illustration. Follow the sequence of numbers which will

simplify the gradual stringing of the seed beads and the connection of the individual rows into openings and columns. The illustration depicts the creation of a strong bracelet which consists of an original three-dimensional seed bead structure. The bracelet is assembled from two rows of square shaped openings. The upper opening begins halfway along the lower one.

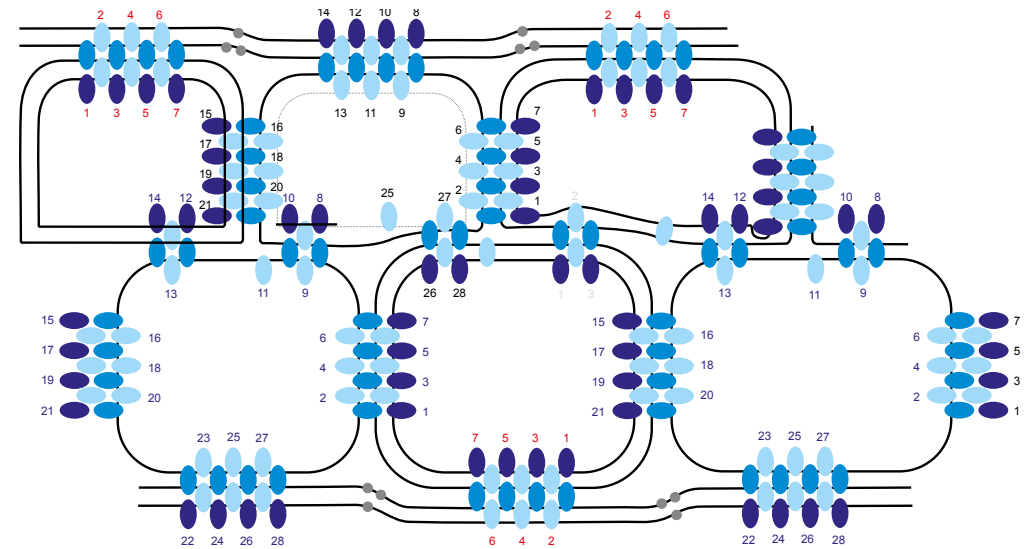
Every column has four seed bead sides. They consist of columns created along the circumference using four T. The columns mesh together at the site where they pass through the holes. Their length consists of the four lower T and the sides of only three T.

From the upper view, the pillars meet and create an almost right angle for the squares, while two T meet in the corners. The square stringing is created by four parts consisting of seven T which always alternate from one side to the other. Insert 10/0 rocailles between the squares along the circumference at the upper and lower edges (2x at the upper edge and 1x at the lower edge).



-  PRECIOSA Twin™ from the lower circumference
-  PRECIOSA Twin™ from the upper circumference
-  Side PRECIOSA Twin™ with the opening
-  PRECIOSA rocaille 10/0
-  the line designating the threading of the nylon line (the opening, the upper and lower edge)

1,2,3,4,5,6,7,8,9,10,11,12,13,14,15,16,17,18,19,20,21,22,23,24,25,26,27,28 - the connection sequence  
 1,2,3,4,5,6,7 - the connection sequence when threading the edges  
 1,2,3,4,5,6,7,8,9,10,11,12,13,14,15,16,17,18,19,20,21—25,26,27,28 - the connection sequence at the upper openings  
 1,2,3 - the connection sequence of part of every second upper opening

### THE BASIS FOR THE FIRST OPENING

